



The picture shows an example of use that, in connection with firearms, is subject to prohibitions and exceptional caveats under gun and hunting laws. Use in connection with firearms is only allowed if you have a gun/hunting permit. The depicted firearm is not included. You must hold a permit to purchase this item.

ZEISS thermal imaging devices



www.zeiss.com/thermal-imaging

Seeing beyond

HOW THERMAL IMAGING DEVICES WORK.

Thermal imaging devices for hunting applications differ greatly from traditional optical devices for observation, such as binoculars and riflescopes. The optoelectronic devices are more comparable to digital cameras. A thermal imaging camera detects and measures the infrared energy emitted by objects. Using an image processing algorithm, the processor creates a colored representation of the object's temperature based on the signals from the individual pixels. In this context, each temperature value is assigned to a specific color. In addition, thermal imaging photos and videos can be recorded and transmitted via smartphone. Below we explain how they work and their individual components.

Functionality

While the light sensitivity of conventional digital cameras lies in the visible range of the human eye, thermal imaging cameras operate in the long-wave infrared range. This allows them to detect the thermal radiation emitted by a body independent of the available visible light, which is why thermal imaging devices can be used both in daylight and in total darkness.

Lens

The lenses are made of germanium, an element which transmits light in the required wavelength range. Germanium is extremely hard and is therefore always used when particularly robust and resistant optics are required.

High-quality eyepiece

Similar to the lens, the thermal imaging device's eyepiece also features high-quality optics. This allows the relaxed eye focused to infinity to view the image shown on the viewfinder display.

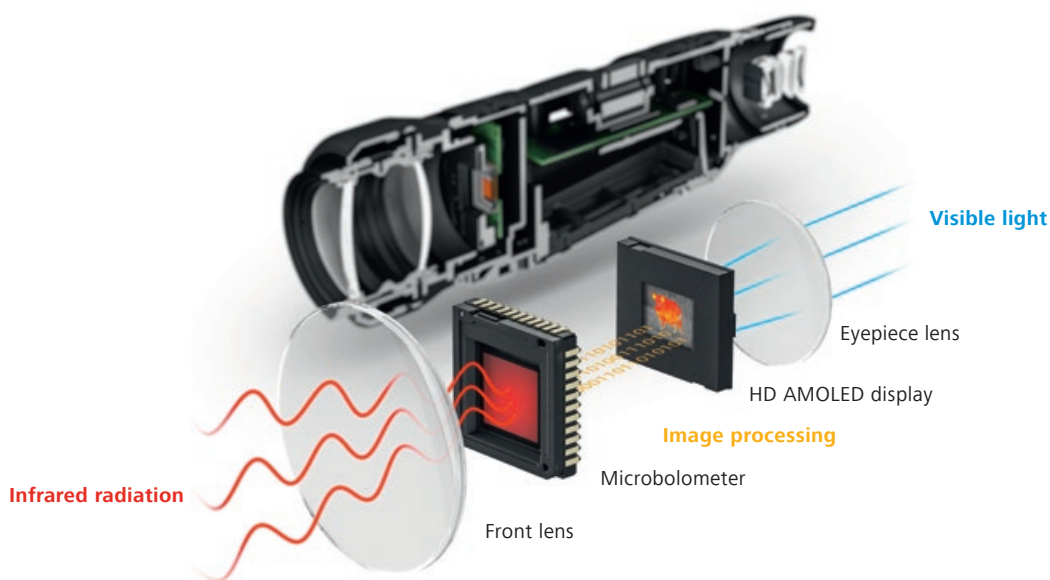

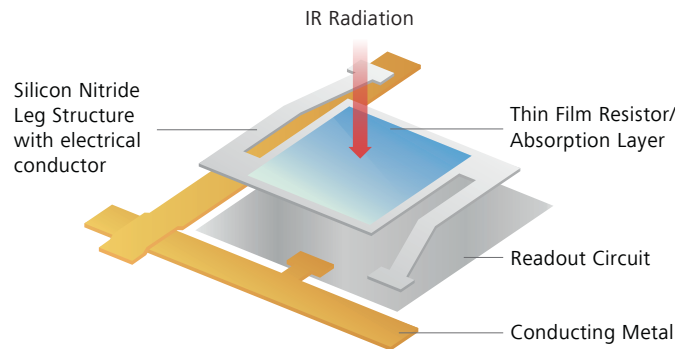

Schematic illustration of a microbolometer.

Sensor

The sensor of a thermal imaging camera is known as a microbolometer. This mainly consists of amorphous silicon (ASI) or vanadium oxide (VOx). The electrical resistance of both materials is highly dependent on the temperature.

Adjustable color display

Depending on the area of application and how clearly the hunter wants to be able to recognize individual details in the subject, as well as their personal taste, different display modes (e.g., White Hot, Black Hot, Red Hot, Rainbow) in shades of gray or color can be selected for the image displayed on the thermal imaging camera's color screen. In addition, the overall brightness of the display can be varied to adjust it in order to suit eyes adapted to either light or dark.

Image processing

The electronic signal coming from the sensor is first digitized and then optimized via a complex image processing algorithm and adapted to the respective hunting situation. The perfect compatibility of the hardware components (lens, sensor, display, eyepiece) with the internal signal processing algorithm ultimately determines the visible image quality and how well relevant details can be recognized during an observation.

Shutter

Just like a digital camera, this can be used to control the amount of radiation passing through the lens. This shutter interrupts the infrared radiation that strikes the detector at regular intervals so that the detector can recalibrate itself from time to time. This produces the quiet clicking sound typical of thermal imaging devices.

Auto exposure system/ infrared detector

A thermal imaging camera is equipped with an "auto exposure" system, so to speak – depending on the ambient conditions, i.e., the changing temperature conditions, the temperature differences across the subject being viewed are divided into brightness or color differences in the best possible way. This produces a bright and high-contrast image for the viewer under all conditions. The resulting image does not reproduce the original colors of the object, but only shows temperature differences. The greater the temperature differences between the observed object and the environment, the more clearly its details and edges can be seen. In this process, the camera's image processing algorithm automatically adjusts the brightness and contrast.



Example of use – observe prohibitions in gun and hunting laws!*

ACCURATE. DURING NIGHT HUNTING. INTUITIVE AND CUSTOMIZABLE. **ZEISS DTC 3**

The ZEISS DTC 3 Thermal Imaging Clip-Ons stand out thanks to their best-in-class optics, outstanding ease of use, and intelligent features – for maximum hunting success at night.

Not only the darkness, but the fog and cold are special challenges hunters regularly face when hunting at night. With the ZEISS DTC (Digital Thermal Clip-On) 3/25 & 3/38, hunters are prepared for any situation, no matter how demanding, and can count on the best optics, a detailed image, intuitive ergonomics, and the greatest possible flexibility – whether in the open field or in the forest.

Sensor-enabled standby mode



The angle sensor automatically detects the exact position of the ZEISS DTC 3 and activates standby mode at a lateral angle of 45° and at a downward or upward angle of 70°. When the hunter brings the weapon back to the firing position, the device automatically exits standby mode.

*The picture shows an example of use that, in connection with firearms, is subject to prohibitions and exceptional caveats under gun and hunting laws. Use in connection with firearms is only allowed if you have a gun/hunting permit. The depicted firearm is not included. You must hold a permit to purchase this item.

RELIABILITY AND PRECISION IN THE DARK.

Customizable

The ZEISS DTC 3 can be connected to the ZEISS Hunting App via Bluetooth and then adapted to your own needs and requirements. In addition, you can save up to four profiles for different riflescopes.



Easy to use

Thanks to the central positioning of the focusing turret and the intelligent layout of the buttons, the ErgoControl operating concept offers outstanding ease of use – both for left-handed or right-handed users and when wearing gloves.



10 h
of battery life
in continuous
use!

Always ready

With 10 hours of battery life in continuous use, the ZEISS DTC 3 can be used to observe for particularly long periods. The standby mode activated by the angle sensor additionally extends battery life. The device can even be charged directly in the field via a portable, external power bank.



Fast and precise zeroing

The zeroing assist that can be operated via the ZEISS Hunting App calculates the compensation values after entering the point of impact deviation, realigns the display accordingly and thus automatically centers the reticle. This eliminates the need to calculate clicks and makes the process much faster and hassle-free.



Accurate

Perfectly compatible components and an advanced image processing algorithm enhance night vision for an ethical hunt.



MAXIMUM FLEXIBILITY DURING NIGHT HUNTING WITH THE ZEISS HUNTING APP.

The ZEISS Hunting App offers numerous features, such as the ability to capture, manage, document, and synchronize current happenings and hunting experiences directly from the field. The decisive advantage is that personal settings can also be configured via the app.

Configurable. For personalized hunting experiences.

The ZEISS DTC 3 can be connected to the ZEISS Hunting App via Bluetooth and adapted to your own requirements. One particularly convenient feature is that once the combination of ZEISS DTC 3 and riflescope has been zeroed, the hunter can save the setting as a profile in the app and easily switch the clip-on from one riflescope to the other. The ability to save up to four shooting profiles adds an impressive level of flexibility.



ZEISS HUNTING APP



Save up to four zeroing profiles. Capture and share current happenings and experiences right on the spot. It's all possible with the ZEISS Hunting App! Also available as a browser version.

Download the app
for iOS or Android
for free today!

App Store



Google Play



*The picture shows an example of use that, in connection with firearms, is subject to prohibitions and exceptional caveats under gun and hunting laws. Use in connection with firearms is only allowed if you have a gun/hunting permit. The depicted firearm is not included. You must hold a permit to purchase this item.

Can be operated via app

The ZEISS DTC 3 can be connected to the ZEISS Hunting App via Bluetooth and then adapted to your own requirements. For example, hunters can select which icons are displayed on the screen and customize the information presented to suit their needs. The ZEISS DTC 3's control buttons can also be mirrored onto a smartphone – turning it into a flexible remote control.

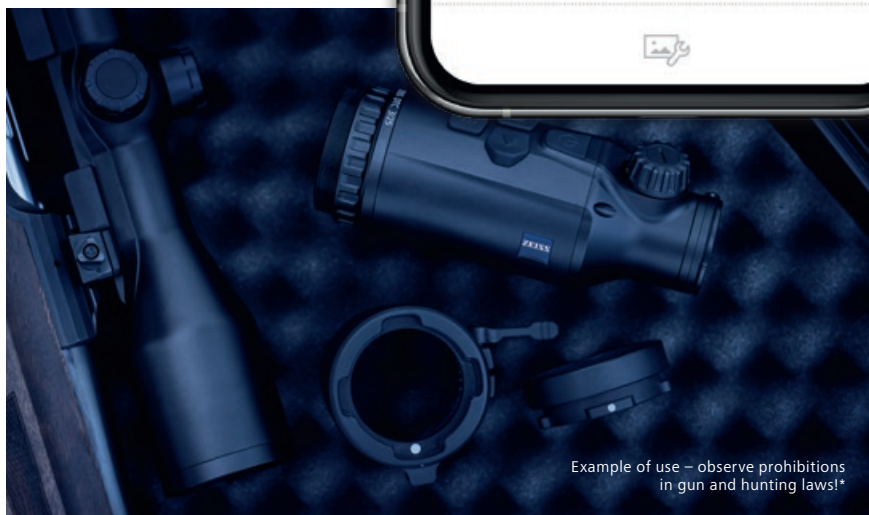
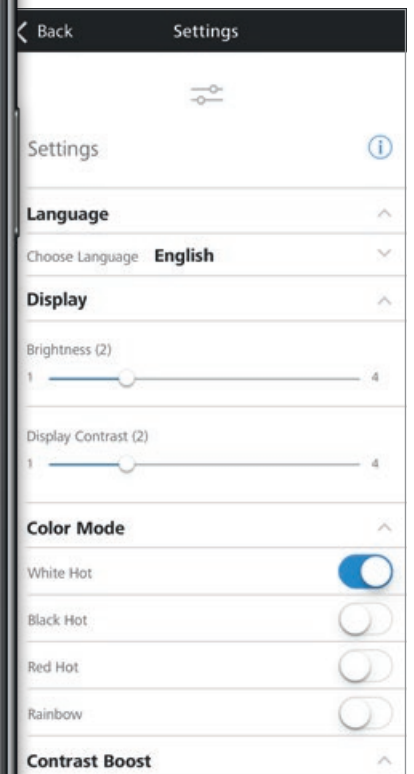
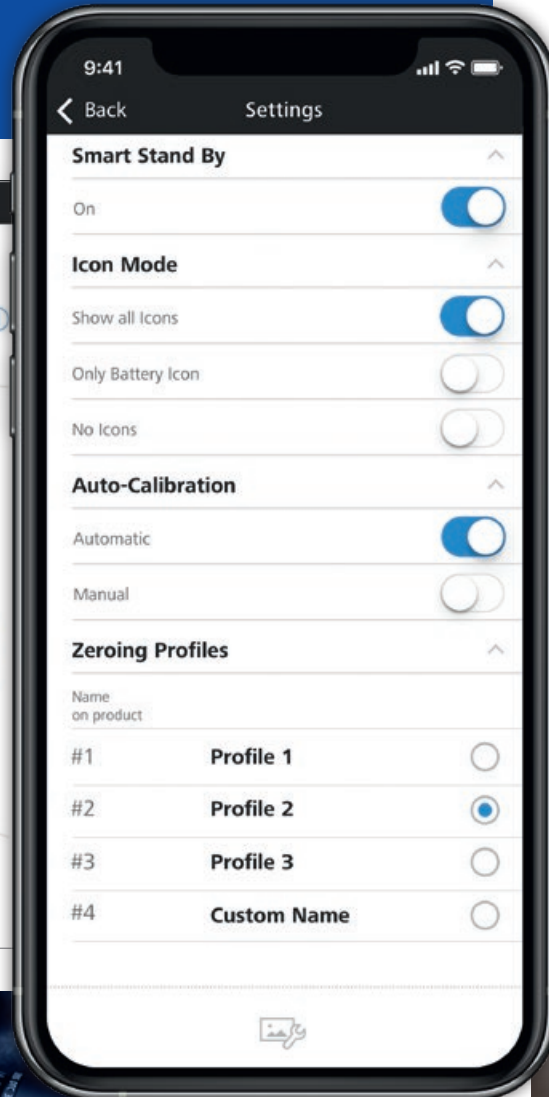
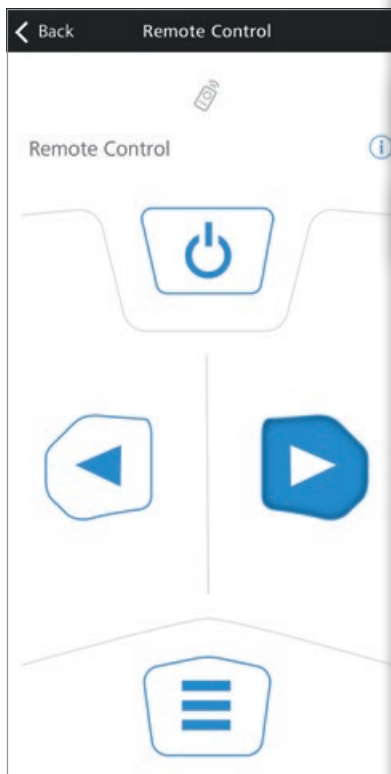

Example of use – observe prohibitions in gun and hunting laws!*



Example of use – observe prohibitions in gun and hunting laws!*

ALWAYS READY

THANKS TO A SOPHISTICATED POWER MANAGEMENT.



Example of use – observe prohibitions in gun and hunting laws!*

Every hunter knows that a night hunt can sometimes last a long time. This not only requires patience, but also reliable battery performance. The ZEISS DTC 3 models offer 10 hours of continuous battery life, allowing for virtually unlimited use. In addition, the ZEISS DTC 3 can also be recharged via a portable power bank, if necessary.

Automatic standby mode

The angle sensor automatically detects the exact position of the clip-on and activates standby mode at a lateral angle of 45° and at a downward or upward angle of 70°. When the hunter brings the weapon back to the firing position, the ZEISS DTC 3 automatically exits standby mode. Standby mode can, however, also be deactivated by briefly pressing the power button.

OPTICAL EXPERTISE

Field of view comparison.

The ZEISS DTC 3/38 is optimized for higher magnification levels, as the full field of view can already be used when the riflescope is at 3× optical magnification. Our especially popular 3–12×56 riflescope is one of the models that you can combine with the ZEISS DTC 3/38 to benefit from a full field of view at 3× magnification. Numerous competitors only offer this advantage at lower magnifications.

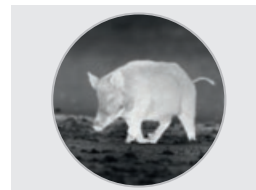

View through a competing clip-on



View through the **ZEISS DTC 3**

*The picture shows an example of use that, in connection with firearms, is subject to prohibitions and exceptional caveats under gun and hunting laws. Use in connection with firearms is only allowed if you have a gun/hunting permit. The depicted firearm is not included. You must hold a permit to purchase this item.

CONVENIENT ZEROING THANKS TO THE DIGITAL ZEROING ASSIST.

Every millimeter is crucial during the hunt, which is why an exact adjustment is so important during the zeroing process. The precise zeroing assist for the ZEISS DTC 3/25 and 3/38 is very easy to operate via the ZEISS Hunting App and thus makes the zeroing process not only faster, but also simpler and more convenient.

The hunter only has to enter the distance and the location of the hit into the app. The assist then independently calculates the corrective values and realigns the display accordingly. This eliminates the need to calculate clicks and makes the process much faster and hassle-free.

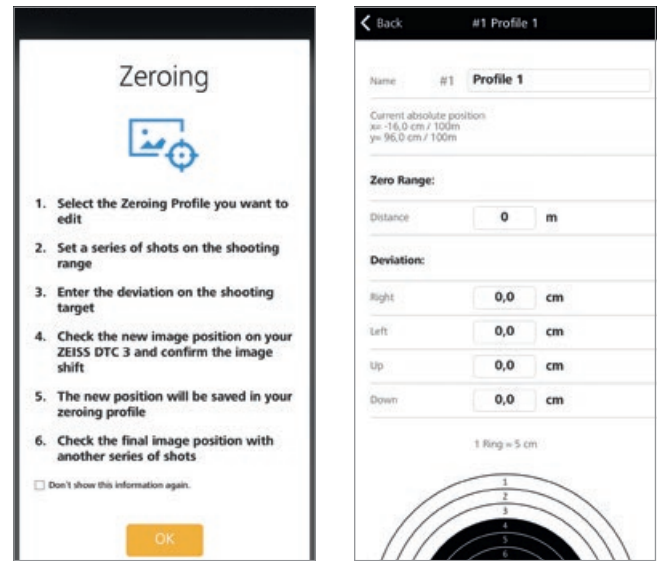

Zeroing via the ZEISS Hunting App



Example of use – observe prohibitions in gun and hunting laws!*

THE ZEISS DTC 3/25 & 3/38 MODELS. COMPARISON OF BENEFITS.



ZEISS DTC 3/25

Particularly in the forest, the ZEISS DTC 3/25 – with its large field of view of 18.4 meters at a distance of 100 meters – offers a crucial overview and the ability to easily recognize details. Due to these outstanding optics, when they spot game hunters are perfectly equipped to react quickly, even at short distances and in total darkness.



ZEISS DTC 3/38

Range and accuracy at long distances play a crucial role in night hunting in open terrain. The ZEISS DTC 3/38 covers a larger area, has a field of view of 12.3 meters at 100 meters, and an accurate click value of 1.6 cm at 100 meters – for extremely precise zeroing and thus highly accurate and ethical shots.

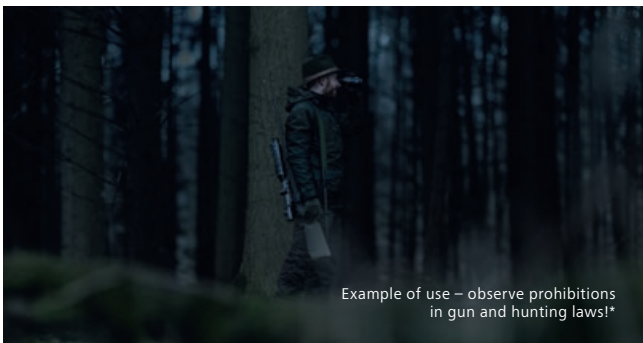
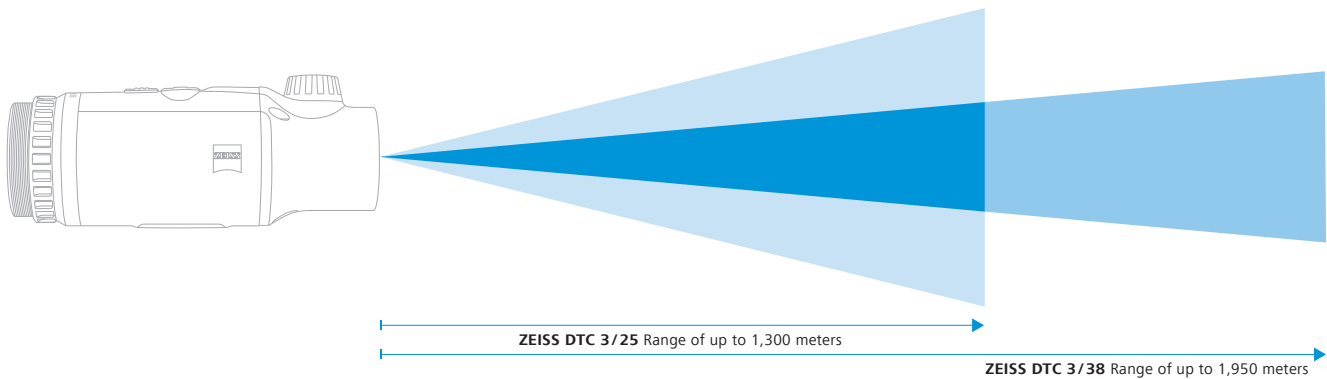

With a field of view of 18.4 meters at 100 meters, the ZEISS DTC 3/25 provides the best overview for night hunting in forested areas.

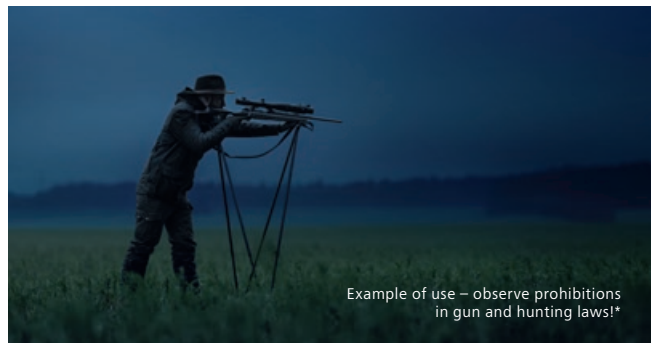

Thanks to a range of up to 1,950 meters, the ZEISS DTC 3/38 is perfect for identifying game at longer distances.

*The picture shows an example of use that, in connection with firearms, is subject to prohibitions and exceptional caveats under gun and hunting laws. Use in connection with firearms is only allowed if you have a gun/hunting permit. The depicted firearm is not included. You must hold a permit to purchase this item.

TECHNICAL SPECIFICATIONS.

Model	Thermal Imaging Clip-On	
	ZEISS DTC 3/25	ZEISS DTC 3/38
Optics		
Focal length	25 mm / F1.0	38 mm / F1.0
Lens type	Germanium	
Range	~ 1,300 m	~ 1,950 m
Field of view in m at 100 m	18.4 m	12.3 m
Field of view in degrees (horizontal × vertical)	10.5° × 7.9°	7° × 5°
Optical magnification	1 ×	
Maximum image adjustment X to 100 m	±307 cm	±205 cm
Maximum image adjustment Y to 100 m	±230 cm	±154 cm
Adjustment per click at 100 m	2.4 cm	1.6 cm
Sensor		
Sensor resolution	384 × 288 px	
Sensor pixel pitch	12 µm	
Frame rate	50 Hz	
Display		
Display resolution	1024 × 768 px	
Display type	AMOLED	
Electronics		
Interfaces	USB: charging Bluetooth: data transfer	
Battery	Lithium-ion	
Battery life	10 h	
External power supply (not included in the package)	5V / 2 A (USB)	
Connection to other devices	ZEISS Hunting app, Bluetooth	
General		
Ingress protection rating	IP65 / IP67 (protection against heavy rain)	
Operating temperature range	-10 °C to +50 °C	
Length × width × height	150 mm × 60 mm × 65 mm	164 mm × 60 mm × 65 mm
Weight	560 g	650 g
Order no.	527030	527031

Subject to changes in design and scope of delivery as a result of ongoing technical development.

ACCESSORIES

ZEISS DTC adapter

ZEISS offers the DTC adapter as an accessory to conveniently mount the clip-on to the riflescope. Once the combination of ZEISS DTC 3 and riflescope has been zeroed in, the ZEISS DTC 3 can be easily switched from one riflescope to the other with the aid of a two-part adapter – without changing the point of impact and having to be zeroed in again.





IDENTIFY MORE DETAILS. WITH EXCELLENT IMAGE QUALITY. ZEISS DTI 6

The new ZEISS DTI 6 thermal imaging cameras offer unprecedented image quality that allows you to recognize an exceptional level of detail.

When hunting in the dark, you have to recognize every detail in order to reliably identify your target. The innovative ZEISS Smart Image Processing Pro algorithm (ZSIP Pro) developed by ZEISS, in combination with the 640×480 sensor with 12 micron pixel pitch and the 1024×768 HD AMOLED display, produces particularly high-contrast and detailed images. Identify individual details even more reliably in order to more quickly and reliably identify your target – for maximum hunting success.

ZEISS Smart Image Processing Pro (ZSIP Pro)



Standard image processing



ZSIP Pro

The ZSIP Pro image processing algorithm delivers a detailed and clear image thanks to high-precision sharpness and contrast optimization. Each image is divided into equally sized tiles and optimized individually. The image processing algorithm then compares the differences and combines them into a uniform, high-contrast image.

MAXIMUM IMAGING PERFORMANCE IN COMPLETE DARKNESS.

Revolutionary ergonomics and power management

The ZEISS DTI 6 features intelligent user interfaces designed for rapid interactions when every second counts. Thanks to innovative power management, the ZEISS DTI 6 can be used continuously for 6.5 hours.

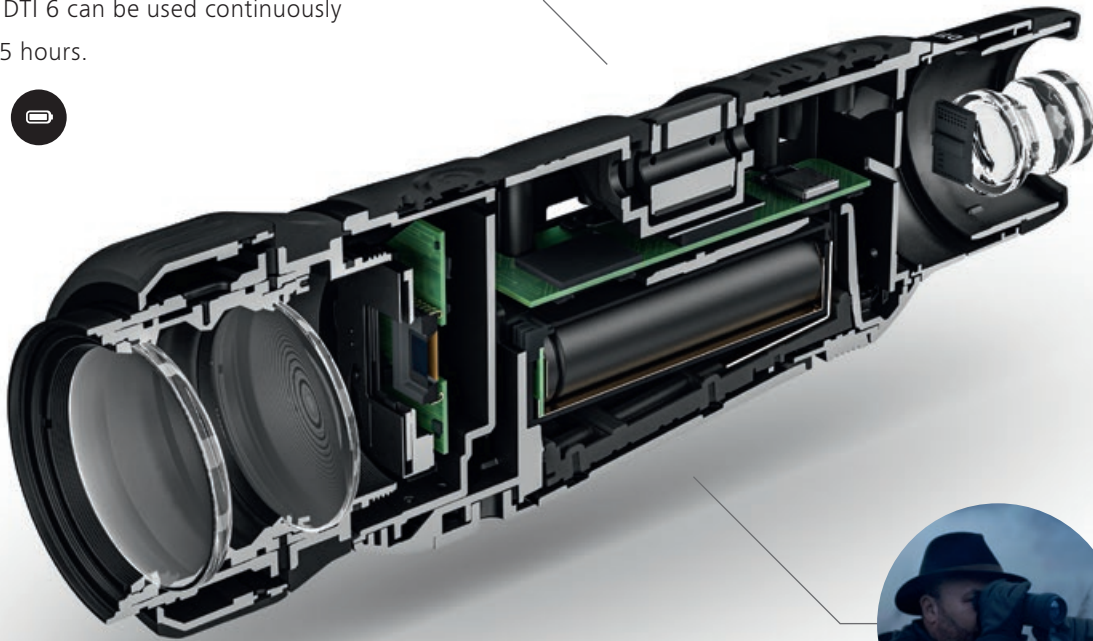

Outstanding build quality and precision

Thanks to outstanding build quality “Made in Germany” and super-smooth and precise mechanical components, the ZEISS DTI 6 has a premium feel during operation and achieves the best possible thermal performance.

Unparalleled image quality

Thanks to its high-end eyepiece, state-of-the-art hardware, and the ZEISS ZSIP Pro image processing algorithm, the ZEISS DTI 6 delivers an impressive viewing experience in all hunting situations.



ZEISS DTI 6.

ALL THE FEATURES AT A GLANCE.

ZSIP Pro image processing algorithm

ZSIP Pro uses a three-step image processing algorithm to optimize thermal images. In the first step, unwanted noise is removed from the sensor's output signal. In the next step, the image is divided into sections that are individually optimized with respect to contrast and then adjusted to match each other. In the final processing step, the areas of the image with heat sources are optimized for sharpness. This creates an optimal image with sharp distinctions between the game and its surroundings.

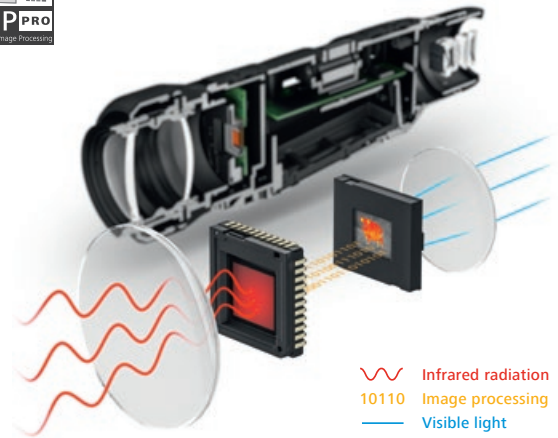

Predefined observation modes

There are four predefined viewing programs (Universal, Fog, Detect, Identify) that allow hunters to quickly and perfectly tailor the ZEISS DTI 6's image to the situation at hand.



Mode "Universal"



Mode "Fog"

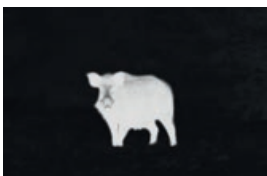

Mode "Spot"



Mode "Identify"

For illustration purpose only.

Individual configuration options

With the help of numerous individual configuration options, hunters can make the DTI 6 thermal imaging camera their very own. From selecting your preferred zoom speed to adjusting the duration of the standby timer and the status LED configuration to creating your own color palettes, the ZEISS DTI 6 can be customized to suit your specific needs – and the configuration can be saved as one of up to five different observation profiles.



OPTICAL EXPERTISE

DynamicZoom Concept

The DynamicZoom Concept enables fast and precise zooming to reliably identify targets. Hunters can find the right magnification level at any distance, allowing them to quickly select their perfect combination of zoom and level of detail for the distance at which they are currently observing.



Interchangeable lens for any hunting situation

The ZEISS DTI 6 can be used with a 20 mm focal length lens and a 40 mm focal length lens. Thanks to a screw thread, the ZEISS DTI 6 lenses can be easily swapped out, allowing the camera to be adapted to any hunting situation quickly and easily.



Power management

The ZEISS DTI 6's removable battery delivers 6.5 hours of continuous observation time. In addition, a special feature – Touchless Standby – saves valuable battery power. The standby mode is activated contactless – if the DTI 6 is put down or picked up, it switches itself off or on. In addition, the ZEISS DTI 6 can also be charged via a power bank, which provides additional peace of mind when out in the field at night.



OPTICAL EXPERTISE

The most impressive viewing experience on the market

The ZEISS DTI 6 models feature a field of view that almost completely fills up the display, creating an extremely immersive viewing experience. Numerous competing models don't offer this benefit and therefore have a much smaller effective field of view.



Viewing experience with competing model



Immersive viewing experience with **ZEISS DTI 6**

MAXIMUM PERFORMANCE FOR FOR MAXIMUM HUNTING SUCCESS. **ZEISS DTI 6.**



6.5 hour
battery life +
removable
battery!

The highlights of the ZEISS DTI 6.

- Innovative ZEISS Smart Image Processing Pro (ZSIP Pro) algorithm
- 640×480 sensor with 12 micron pixel pitch
- 1024×768 HD AMOLED display
- 1.5×/3.0× optical magnification and up to 10× digital zoom
- Specially designed eyepiece for an ultra-immersive viewing experience
- Removable battery (6.5-hour battery life)
- Made in Germany

ENHANCE YOUR EXPERIENCE. WITH PERFECT ACCESSORIES.

CHARGING ACCESSORIES



Rechargeable li-ion battery

High-quality lithium-ion battery with a capacity of 3,200 mAh for long periods of observation with the ZEISS DTI 6. Practical as an additional battery when a power grid isn't available to charge the thermal imaging camera.



Charging cradle

This charging cradle from ZEISS makes it easy to charge the DTI 6 battery. The charging cradle is lightweight, fits in any pocket, and fully charges the battery in only 180 minutes*.

* USB-C at 15 W (5V/3A)

OPTICAL ACCESSORIES

Interchangeable 20 mm lens

Equipped with the 20mm lens, the ZEISS DTI 6/20 is ideally suited for observing game in forested areas.



Interchangeable 40 mm lens

The long 40 mm focal length of the ZEISS DTI 6/40 offers a longer range for use in the open field.



ZEISS HUNTING APP

Stay connected – with the ZEISS Hunting app.

Depending on the thermal imaging device, the ZEISS Hunting app offers a variety of benefits and features.

With the ZEISS DTI 3 models, you can manage and share photos and videos via the app and follow hunting experiences in the live stream. The ZEISS DTI 6 thermal imaging cameras and DTC 3 thermal imaging clip-ons can also be programmed and customized using the app. You can save up to five personal profiles in the app. To ensure that the software is up to date, we continuously work on firmware updates for all of our thermal imaging devices and make them available via the ZEISS Hunting app.



Further information about the app is available at zeiss.com/hunting/app
The browser version is available at hunting.zeiss.com

VIEW THE NIGHT IN **DETAIL.**

ZEISS DTI 6/20 & DTI 6/40.



ZEISS DTI 6/20

The ZEISS DTI 6/20 is the perfect thermal imaging device for hunting in forested areas. With an impressive field of view of 38m/100m, it delivers a perfect overview at short distances, making precise observation, reliable identification, and thus the greatest hunting success possible.



A clearer view when hunting in the forest – the ZEISS DTI 6/20 offers an excellent overview in forested areas with a focal length of 20 mm.



ZEISS DTI 6/40

The ZEISS DTI 6/40 has been designed specifically for hunting in the open field and, with a range of up to 2 km and 3× optical magnification, ensures that details are easily identifiable, even at longer distances.



Identify details at greater distances – with a focal length of 40 mm, the ZEISS DTI 6/40 also makes it possible to detect distant game in the field.

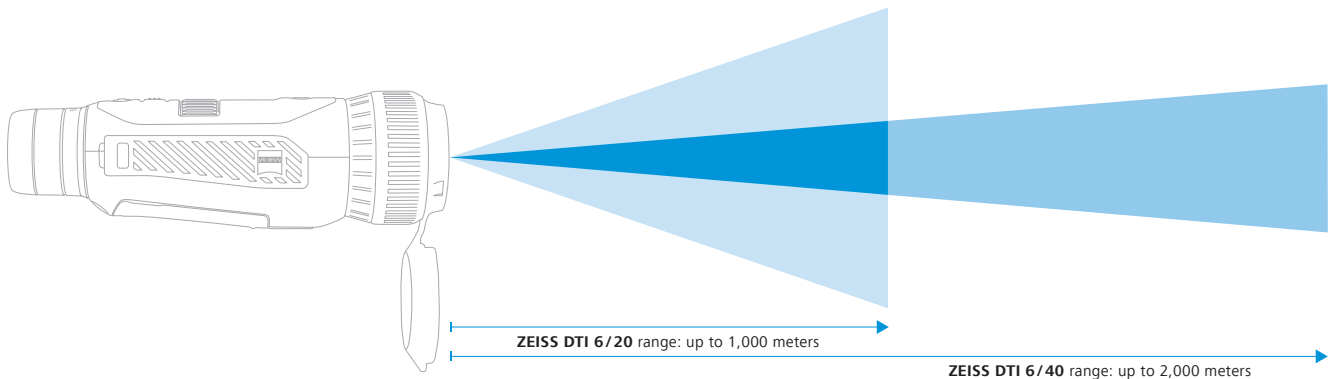

TECHNICAL SPECIFICATIONS.

Model	Thermal Imaging Camera	
	ZEISS DTI 6/20	ZEISS DTI 6/40
Optics		
Focal length	20 mm / F1.0	40 mm / F1.0
Lens type	Germanium	
Range	~ 1,000 m	~ 2,000 m
Eyepiece field of view in ° (subjective field of view)	Diagonal: 40°	
Lens field of view in m at	38 m	19 m
Lens side field of view in ° (horizontal × vertical)	22° × 16°	11° × 8,2°
Optical magnification	1.5 ×	3.0 ×
Maximum digital zoom	10 ×	
Variable zoom increments	0.1 × – 1.0 ×	
Sensor		
Sensor resolution	640 × 480 px	
Sensor pixel pitch	12 μm	
Frame rate	50 Hz	
Display		
Display resolution	1024 × 768 px	
Display type	HD AMOLED	
Electronics		
Interfaces	USB: charging + data transfer Wi-Fi: data transfer Bluetooth: data transfer	
Battery	Lithium-ion	
Battery life	6.5 hours	
External power supply	5 V / 3 A, 9 V / 2 A, 12 V / 1.5 A (USB)	
Internal memory	16 GB	
Video / image / livestreaming feature	Yes	
Wi-Fi frequency	2,4 GHz	
Wi-Fi standard	IEEE 802.11b / g / n	
Connection to other devices	ZEISS Hunting app / USB	
General		
Ingress protection rating	IP 65 / IP 67	
Operating temperature range	–20 °C to +50 °C (–4 °F / +122 °F)	
Length × width × height	230 mm × 62 mm × 68 mm	228 mm × 69 mm × 73 mm
Weight	690 g	755 g
Order number	527020-9901	527020-9902

Subject to changes in design and scope of delivery as a result of ongoing technical development.

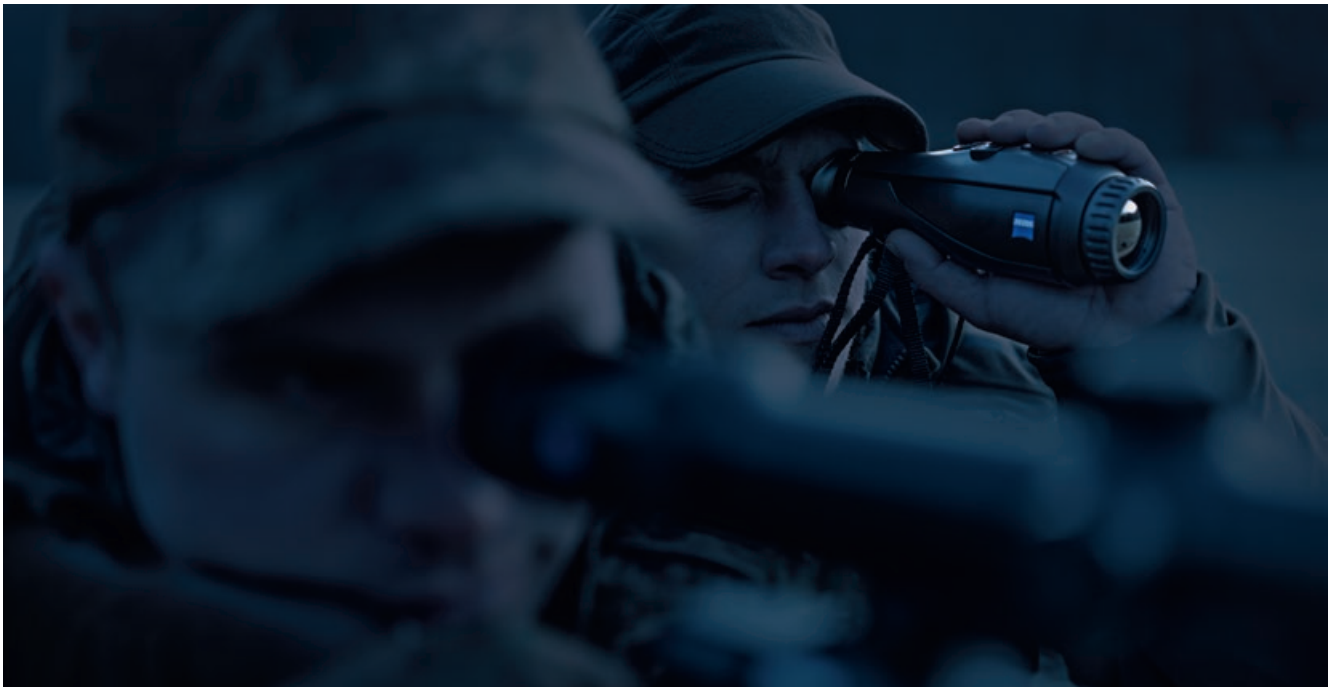

HANDLE THE NIGHT. INTUITIVE AND ERGONOMIC. ZEISS DTI 3

The ZEISS DTI 3 models – technologically innovative optical devices for the night in familiar ZEISS quality and a one-of-a-kind, ergonomic design.

Hunting at night is a special experience for many hunters – but one that places high demands on the equipment used. With its DTI 3 thermal imaging cameras, ZEISS always offers the right optical devices for nighttime hunting. Designed by hunting experts specifically for hunting, they produce detailed images to accurately identify targets, even in the dark.

ErgoControl Concept

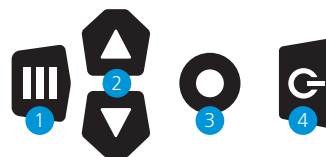

- 1 Menu | Color Modes
- 2 Zoom | Menu Navigation
- 3 Video | Photo
- 4 On/off button

Thanks to the intelligently positioned buttons, all of the functions can be controlled intuitively. The perfectly shaped controls can be quickly identified – even in the dark or when wearing gloves.

DETAILED IMAGES – EVEN IN TOTAL DARKNESS.

Precise zoom

The fine, gradual zoom adjustment in 0.5× increments offers the perfect combination of magnification and detail recognition.



Enhanced camouflage

Thanks to the LED Off feature, the device's status display can be switched off manually, thus preventing the game from noticing the light – whether when stalking or hunting.



With an extra-long
10h
of battery life!

Extra long battery life

With an impressively long battery life of 10 hours, the ZEISS DTI 3 holds enough charge for two to four hunts. The standby feature conserves battery power by automatically shutting off the thermal imaging camera after 60 minutes of inactivity.



Outstanding optics in familiar ZEISS quality

The high-resolution 1280×960 pixel HD-LCOS display delivers detailed images – even in total darkness.



HANDLE THE NIGHT – THANKS TO INTUITIVE ERGONOMICS.

The ZEISS DTI 3 models owe their outstanding optical performance to the fact that the lens, sensor, electronics, screen, and eyepiece are all perfectly compatible. Above all, however, the DTI 3 family of thermal imaging cameras stands out thanks to its unique ergonomics – the ErgoControl operating concept, with its intelligently positioned buttons, makes it easy to intuitively activate all of the device’s functions.

The perfect ergonomic design offers excellent handling in cold and dark conditions and ensures that both right-handed and left-handed users can operate the device comfortably.

Perfect ergonomics

Thanks to the ErgoControl operating concept with its intelligently positioned buttons, all of the functions can be controlled intuitively.



ErgoControl Concept for intuitive operation

Contrast enhancement in foggy conditions

The Contrast Boost feature maximizes contrast to see as much detail as possible, even in foggy or humid conditions.



Contrast Boost Off



Contrast Boost On

Improved focusing

In picture-in-picture mode, a focus frame highlights the enlarged image section. For improved focusing and a successful, ethical hunt.



Picture-in-picture mode

AREAS OF EXPERTISE COMBINED

During the development of the DTI 3 models, which are the first thermal imaging devices from ZEISS, the company brought two different areas of expertise together. This is because only ZEISS' more than 130 years of experience in the fields of hunting and photography have made it possible to develop thermal imaging optics that stand out not only for their outstanding image quality, but also for their unique, intuitive ergonomics that maximize hunting success.

Learn more at www.zeiss.com/nighthunting



VIEW THE NIGHT IN DETAIL. ZEISS DTI 3 / 35 & DTI 3 / 25.



ZEISS DTI 3 / 25

Whether in wooded areas or at the bait site – this high-quality thermal imaging system offers a wide field of view of 26 meters at a range of 100 meters. Thanks to its outstanding optics, the ZEISS DTI 3 / 25 thus provides a perfect overview that reliably detects heat sources, especially at short distances.



The ZEISS DTI 3 / 25 offers an extremely wide field of view of 26 meters at 100 meters, making it ideal for hunting in wooded areas or at the bait site.



ZEISS DTI 3 / 35

Whether for observing and tracking or to more quickly and accurately identify game, this high-quality thermal imaging system ensures that hunters can precisely recognize details even at distances of more than 1,200 meters. As a result, the ZEISS DTI 3 / 35 gives hunters a considerable advantage when stalking at night or when hunting over long distances from a raised hide in a field.



Thanks to a range of up to 1,200 meters, the ZEISS DTI 3 / 35 is ideal for hunting from a raised hide in a field over long distances.



HOW TO USE ALL THE FEATURES OF THE ZEISS HUNTING APP



Share your hunting successes, document your hunting experiences, manage your hunting equipment, create ballistic profiles, and much more. The ZEISS Hunting app can be easily connected to all ZEISS thermal imaging clip-ons via WLAN (or Bluetooth, depending on the model).

Video tutorials showing how to use all the features of the ZEISS Hunting app can be found on YouTube:



TECHNICAL SPECIFICATIONS.

Model	Thermal Imaging Camera	
	ZEISS DTI 3/35	ZEISS DTI 3/25
Optics		
Focal length	35 mm / F1.0	25 mm / F1.0
Lens type	Germanium	
Range	~ 1,235 m	~ 880 m
Eyepiece field of view in ° (subjective field of view)	Diagonal: 30.25°	Diagonal: 30.25°
Lens field of view in m at 100 m	Horizontal: 19 m	Horizontal: 26 m
Lens side field of view in ° (horizontal × vertical)	10.7° × 8°	15° × 11°
Optical magnification	2.5 ×	1.8 ×
Maximum digital zoom	4 ×	
Zoom increments	In 0.5 × increments from 1.0 × – 4.0 ×	
Sensor		
Sensor resolution	384 × 288 px	
Sensor pixel pitch	17 μm	
Frame rate	50 Hz	
Display		
Display resolution	1280 × 960 px	
Display type	LCOS	
Electronics		
Interfaces	USB: charging + data transfer WLAN: data transfer	
Battery	Lithium-ion	
Battery life	10 h	
External power supply	5 V / 3A, 9 V / 2 A, 12 V / 1.5 A (USB)	
Internal memory	15 GB	
Video / photo / livestreaming feature	yes	
WLAN frequency	2.4 Ghz	
WLAN standard	IEEE 802.11 b/g/n	
Connection to other devices	ZEISS Hunting app / USB	
General		
Ingress protection rating	IP 66 (protection against heavy rain)	
Operating temperature range	-10 °C to +40 °C (+14 °F / +104 °F)	
Length × width × height	193 mm × 60 mm × 65 mm	187 mm × 60 mm × 65 mm
Weight	450 g	410 g
Order no.	527010	527011

Subject to changes in design and scope of delivery as a result of ongoing technical development.

FOCUSING ON THE ESSENTIALS.

Benefits



Sensor



Display



Optical quality



Digital zoom



Power management



Connectivity

ZEISS thermal imaging cameras

*charging via power bank possible

ZEISS DTI 3/25

384 x 288 px
17 micron

1280
x
960 px
HD LCOS

Perfect combination of magnification and detail recognition

ContrastBoost function



Fine, gradual zoom adjustment from **1.0x - 4,0x**
Magnification in 0.5x increments

Rechargeable battery with up to 10 hours of power*

Standby mode
Auto-off function

Wi-Fi

Manage and share photos/videos

ZEISS DTI 3/35

384 x 288 px
17 micron

1280
x
960 px
HD LCOS

Perfect combination of magnification and detail recognition

ContrastBoost function



Fine, gradual zoom adjustment from **1.0x - 4,0x**
Magnification in 0.5x increments

Rechargeable battery with up to 10 hours of power*

Standby mode
Auto-off function

Wi-Fi

Manage and share photos/videos

ZEISS DTI 6/20

640 x 480 px
12 micron

1024
x
768 px
HD AMOLED

ZEISS Smart Image Processing Pro (ZSIP Pro) to perfectly recognize details

High-quality germanium lenses



DynamicZoom Concept with **1.0x - 10,0x** magnification

Quick-swap battery with up to 6.5 hours of power*
Touchless standby
Auto-off function

Wi-Fi and Bluetooth
Manage and share photos/videos
Programmable and customizable via app (five profiles)

ZEISS DTI 6/40

640 x 480 px
12 micron

1024
x
768 px
HD AMOLED

ZEISS Smart Image Processing Pro (ZSIP Pro) to perfectly recognize details

High-quality germanium lenses



DynamicZoom Concept with **1.0x - 10,0x** magnification

Quick-swap battery with up to 6.5 hours of power*
Touchless standby
Auto-off function

Wi-Fi and Bluetooth
Manage and share photos/videos
Programmable and customizable via app (five profiles)

ZEISS thermal imaging clip-on

ZEISS DTC 3/25

384 x 288 px
12 micron

1024
x
768 px
AMOLED

High-quality germanium lenses

ContrastBoost function

No digital zoom, riflescope magnification can be used

Rechargeable battery with up to 10 hours of power*

Angle sensor-enabled standby mode

Wi-Fi and Bluetooth
Digital zeroing assistant via app
Programmable and customizable via app (four profiles)

ZEISS DTC 3/38

384 x 288 px
12 micron

1024
x
768 px
AMOLED

High-quality germanium lenses

ContrastBoost function

No digital zoom, riflescope magnification can be used

Rechargeable battery with up to 10 hours of power*

Angle sensor-enabled standby mode

Wi-Fi and Bluetooth
Digital zeroing assistant via app
Programmable and customizable via app (four profiles)

Main use



Raised hide/
forest



Stalking/
forest



Raised hide/
field



Stalking/
field



Optical
magnification



Field of view
(100m)



Range



DTI 3/25

1.8x

26 m

880 m



DTI 3/35

2.5x

19 m

1,235 m



DTI 6/20

1.5x

38 m

1,000 m



DTI 6/40

3.0x

19 m

2,000 m



DTC 3/25

1.0x

18.4 m

1,300 m



DTC 3/38

1.0x

12.3 m

1,950 m

Become a part of the **ZEISS Hunting community**.

Follow us on the web:



facebook.com/ZEISSHunting



zeiss.com/hunting/blog



youtube.com/user/zeissportsoptics



ZEISShunting_EU



Customer Care

Carl Zeiss Sports Optics GmbH – Customer Care
Gloelstraße 3 – 5, 35576 Wetzlar, Germany
Phone +49-800-934-7733 | Fax +49-644-148-369
consumerproducts@zeiss.com

Carl Zeiss AG

Consumer Products Business Group
Carl-Zeiss-Straße 22
73447 Oberkochen
Germany

www.zeiss.com/hunting

